

GENERIC ENGINE MONITOR (GEM)



USER GUIDE

The Engine Monitor



Before you start - what you should have



What you should have (clockwise from top left):

- Mounting template/Packing list
- The Engine Monitor User Manual
- Front mounting kit (4 x studs/nuts)
- The CANtrak 2600/2610 Display

plus



Other Engine Monitor accessories optionally available (clockwise from top left):

- Trunion Mounting Bracket (Part No. 930293)
- Protective Push on Front Cover
(Part No.165271)
- Behind Dash Mounting Kit (Part No. 900061)
- Power/CAN Harness (Part No. 510623)
- Power/CAN/ GPS harness (Part No. 510626)
(not shown)

1. The Engine Monitor User Manual

Thank you for choosing the Engine Monitor. These pages provide operating instructions for the Engine Monitor which displays J1939 or J1587 - compatible engine/transmission data. Please read through the guide before use.

The Engine Monitor user-configurable application software creates graphical instrument clusters to display parameters and alarms - providing users with a time-saving solution for introducing equipment incorporating higher degrees of electronic display and control.

We hope you will be very happy with this product and have many years of trouble-free operation. If you have any problems or ideas for improvement then we would like to hear from you.

For more information please contact us at: cantrak.info@ka-group.com
web site: www.kongsbergautomotive.com

Section/Contents	Page
2. Understanding The Engine Monitor	4
3. Getting Started	6
4. Soft Keys	7
5. The Tri Display	8
6. The Quad Display	11
7. The Uni Display	12
8. Data Parameters Monitored	13
9. Active and Stored Alarm Lists	18
10. Configuration Menu	20
11. Pop-Up Messages and Warnings	26
12. Adjusting Lighting and Contrast	27
13. Preferred Screen Store	28
14. Keypad Lock	28
15. Connector Pin-Out	29
16. Typical J1939 Wiring Topology	31
17. Installation	32
18. Maintenance and Troubleshooting	34
19. The CANtrak Platform	35
20. Software Development	36
21. Glossary	37
22. Important Safety and Legal Information	38

2. Understanding The Engine Monitor

The Engine Monitor software runs on a CANtrak display (see section 19 for further details on the CANtrak platform) with five soft keys, providing a flexible and intuitive Human-Machine Interface (HMI). The 5 soft keys access a graphical menu structure that uses standard and easily-understood icons to indicate the key's current function. This enables the operator to select the required engine/transmission data and display it in the following formats:

- Analogue gauges
- Digital values
- Historical trend graphs
- Current and stored alarm messages

Additionally, various diagnostic screens are available, allowing detailed investigation of the engine and transmission data stream. The underlying structure of the Engine Monitor and its interaction with the soft keys may be understood by Figure 1. By accessing the Configuration menu, users can customise some of the displayed data to show, for example, metric or imperial units, and various parameters such as the full-scale reading of gauges.

Understanding The Engine Monitor - continued

The Engine Monitor presents a context dependent 'button bar' above the push buttons if any key from 1 to 4 is pressed from left to right - it disappears after 5 seconds of inactivity. This 'top level' button bar shows the basic structure of the Engine Monitor:



Figure 1

Key 1:	Key 2:	Key 3:	Key 4:	Key 5:
Tri Display , or Main Engine Display. Repeat presses cycle the fuel computer through various modes:	Quad Display (user configurable). Repeat presses cycle the display around 3 different quad view options:	Uni Display showing data history (configurable). Repeat presses cycle display through available parameters:	Active Alarm Display . Holding the key brings up Stored Alarms :	Contrast and Lighting adjustment , or - if held for 3 seconds - the Configuration menu :



3. Getting Started

When power is applied to the display, a start-up screen displays for approximately 7 seconds while the display performs a self test. If the display makes a 'bleep-ing' sound for longer than 1 second, self-test has failed. Users can attempt to rectify the fault by restoring factory defaults (see Configuration menu/section 10 for details); if the fault persists, contact your supplier for guidance.

After the start-up screen disappears, the Engine Monitor starts displaying readings on its virtual gauges if it is connected to an active source of data. The Engine Monitor displays the 'main engine display' or tri-screen on initial start-up, but note that after use this changes to the screen that was last displayed (see Preferred Screen Store/section 13 for details). The Engine Monitor display modes are detailed in the following sections.

4. Soft Keys

The Engine Monitor's soft keys simplify the operator interface. In use, the Engine Monitor displays a 'button bar' directly above the soft keys when any of the first 4 keys (keys 1 to 4, starting from the left) are pressed - with icons representing the current function of each key. Figure 2. shows the top level button bar, with icons 1 to 4 representing the gauges and alarms available, and icon 5 an 'exit door'. Repeat presses of these buttons toggles around the display options available. The button bar will disappear after approximately 5 seconds if no further keys are pressed.



*Figure 2. The Engine Monitor's top level button bar menu:
Key 1: Pages icon indicating that further presses cycle through options for the screen being viewed (in this instance fuel computer modes for the main engine display)
Key 2: Quad Display mode
Key 3: Uni Display mode
Key 4: Alarm Display mode
Key 5: Exit door*

5. The Tri Display

This Engine Monitor display mode provides three independent windows, and is intended to show the most frequently accessed vehicle data (RPM, speed, temperature and fuel). To select Tri Display, press any of the first 4 keys to show the top level button bar, and then press key 1 (the left-hand key). The parameter displayed in the top right gauge is user defined, to change the displayed data press key 5 when the button bar is visible and then keys 1 and 2 to cycle through the available parameters. Also the data displayed in the fuel computer window (Bottom left window) may be changed by repeated pressing of key 1, This is explained in more detail in the following pages. Also, attributes such as units and scales may be changed via the Configuration menu (See section 10 for details).



Figure 3.1. Tri Display, accessed via key 1.

Note. Metric units are shown as default, but others may be selected via the Configuration menu.

The top window shows 2 analogue gauges; Engine RPM and Speed (maximum RPM and speed may be set via the Configuration menu). If speed data is not available the right hand gauge will display engine oil pressure. The bottom right window shows coolant temperature. The bottom left window displays the fuel computer.

It is also possible to display speed derived from a GPS module with an NMEA 0183 output - interfaced via the display's RS232 port (contact your Engine Monitor supplier for further information).

5. The Tri Display (Fuel Computer Modes)



Figure 3.2. A fuel computer display.

Note. Metric units are shown as default, but others may be selected via the configuration menu.

The lower left display window provides access to the fuel computer data and also shows fuel tank level. Upon pressing key 1 the fuel computer is highlighted, when highlighted various data can be displayed by repeat pressing of key 1. When first selected a small icon will also appear in the centre of the screen with the text "Hold Reset". Holding key 1 at this time will perform a Trip Reset. After 2 seconds of no key presses the fuel computer will go back to normal and the icon will disappear.

Data Available is similar to an automotive in-car fuel computer.

Below is the list of parameters that can be displayed in the fuel computer window in alphabetical order:

Distance Remaining: Calculated if Fuel Tank Capacity is set and Fuel Rate, Vehicle Speed and Fuel Level are available [Distance]

Fuel Level: If available [Volume]

Fuel Rate: If available [Volume/Hour]

Fuel Remaining: Calculated if Fuel Tank Capacity is set and Fuel Level is available [Volume]

Instantaneous Fuel Economy: Calculated if Vehicle Speed and Fuel Rate are available [Distance/Volume]

Total Engine Hours: If available [Hours]

Total Vehicle Distance: If available [Distance]

5. The Tri Display (Fuel Computer Modes) - continued

Trip Distance: Calculated since last Trip Reset if Total Vehicle Distance is available [Distance]

Trip Engine Hours: Calculated since last Trip Reset if Total Engine Hours is available [Hours]

Trip Fuel: Calculated since last Trip Reset if Total Fuel Used is available [Volume]

Trip Fuel Economy: Calculated since last Trip Reset if Total Fuel Used and Total Vehicle Distance are available [Distance/Volume]

Trip Fuel Rate: Calculated since last Trip Reset if Total Engine Hours and Total Fuel Used are available [Volume/Hour]

Note. A Trip Reset affects all reset-able fuel computer parameters and can be performed by holding key 1 when the Hold Reset icon appears. The icon appears for approximately 2 seconds when the fuel computer window is first selected. Setting Total Fuel Tank Data and Fuel Tank Reset is performed via the Configuration menu.

6. The Quad Display

Quad Display mode provides 4 gauges. To select it, press any of the keys 1 to 4 to show the top level button bar and then key 2. Repeat presses of key 2 cycle the display around 3 separate quad screens: 4 digital gauges, 4 analogue gauges and 4 alternative analogue gauges. All 12 gauges may be selected and configured by users, providing a simple means of creating application-specific views of engine data. Gauges are selected via quad display's 'adjust mode', by pressing key 5 (noted by an arrow icon) when the Engine Monitor is running quad display and the button bar is visible. In adjust mode, corresponding key presses cycle the display through available parameters (listed in section 8). The selected configuration is stored even when power is removed; adjust mode is exited by pressing key 5.



Figure 4. Top row: the 3 default displays available in quad-display, and adjust mode (right) which allows users to select the gauges displayed.

Note. If a parameter is not available from the engine/transmission, it will not be possible to select it. If the parameter becomes unavailable while in view, '- - -' is displayed.



7. The Uni Display

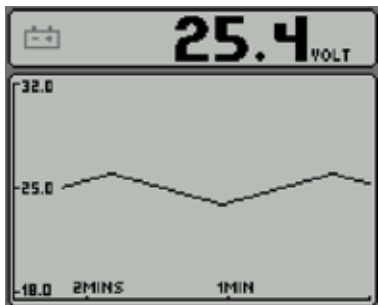

Figure 5. Example graph display plotting battery potential switched.

Note. If a parameter is not available from the engine/transmission, it will not be possible to select it. If the parameter becomes unavailable while in view, '- -' is displayed.

The Engine Monitor's Uni Display mode plots data history in one large window - in an X-Y graph format similar to a pen plotter. This mode is selected by pressing any of the first 4 keys to show the top level button bar and then key 3.





Data is shown in graph form, with the most recent data scrolling from right to left. The viewed time range may be adjusted in the Configuration menu from 2 minutes to 8 hours in six steps. Maximum and minimum values of the Y axis (the reading span) are adjusted automatically to give an optimum view of data. The parameter displayed is selectable by repeatedly pressing key 3 while in the Uni Display mode. The parameters that may be displayed are listed in section 8.

8. Data Parameters Monitored

This table lists the engine and transmission parameters that are monitored via the J1939 and/or the J1587 datalinks. The parameters can be displayed by the Engine Monitor in user-configurable Tri Display, Quad Display or Uni Display modes (✓ indicates the parameter may be selected). DB is an abbreviation for the Engine Monitor's internal database, which stores all data transmitted from the engine/transmission. The complete database list can be accessed on the display via the Configuration menu.

Abbreviations: The units 'MPG' and 'Gal' denote US gallons. For non-US Imperial gallons (UK, Canada, etc) the units are denoted as 'IMPG' or 'IGal'. N = nautical. KTS = knots













Note. If a parameter is not available, it will not be possible to select it. If the parameter becomes unavailable while in view, '- -' is displayed.

Icon	Parameter	Datalinks		Screens			
		J1939	J1587	Tri	Quad	Uni	DB
ELECTRICAL (Volts or Amps)							
	Electrical Potential	✓	✓	✓	✓	✓	✓
	Battery Potential Switched	✓	✓	✓	✓	✓	✓
	Net Battery Current	✓	✓	✓	✓	✓	✓
	Alternator Potential	✓	✓	✓	✓	✓	✓
	Alternator Current	✓	✓	✓	✓	✓	✓











8. Data Parameters Monitored - continued

Icon	Parameter	Datalinks		Screens			
		J1939	J1587	Tri	Quad	Uni	DB
FUEL (L, Gal, lGal) or(L/h, Gal/h lGal/h) or (km/L, MPG or IMPG)							
	Fuel Remaining	✓	✓	✓			✓
	Fuel Rate	✓	✓	✓	✓	✓	✓
	Instantaneous Fuel Economy	✓	✓	✓			✓
	Trip Fuel Economy	✓	✓	✓			✓
	Trip Fuel	✓	✓	✓			✓
	Trip Fuel Rate	✓	✓	✓	✓		✓
None	Total Fuel Used	✓	✓				✓
None	Fuel Leakage 1	✓					✓
None	Fuel Leakage 2	✓					✓
DISTANCE (km, Miles or Nmiles)							
	Distance Remaining	✓	✓	✓			✓
	Trip Distance	✓	✓	✓			✓
	Total Vehicle Distance	✓	✓	✓			✓











8. Data Parameters Monitored - continued

Icon	Parameter	Datalinks		Screens			
		J1939	J1587	Tri	Quad	Uni	DB
PRESSURE (kPa, PSI or bar)							
	Fuel Delivery Pressure	√	√	√	√	√	√
	Barometer Pressure	√	√	√	√		√
AUX 1 	Auxiliary Pressure 1	√		√	√		√
	Boost Pressure	√	√	√	√	√	√
	Air Inlet Pressure	√	√	√	√		√
	Air Filter 1 Differential Pressure	√	√	√	√		√
None	Injector Metering Rail 1 Pressure	√	√				√
None	Injector Metering Rail 2 Pressure	√					√
	Coolant Pressure	√	√	√	√	√	√
	Engine Oil Pressure	√	√	√	√	√	√
	Transmission Oil Pressure	√	√	√	√	√	√
None	Clutch Pressure	√	√				√
None	Air Start Pressure	√	√				√
None	Injection Control Pressure	√	√				√
TEMPERATURE (°C or °F)							
	Engine Coolant Temperature	√	√	√	√	√	√
	Engine Intercooler Temperature	√	√	√	√		√
	Engine Oil Temperature 1	√	√	√	√	√	√

8. Data Parameters Monitored - continued

Icon	Parameter	Datalinks		Screens			
		J1939	J1587	Tri	Quad	Uni	DB
TEMPERATURE (°C or °F)							
	Transmission Oil Temperature	√	√	√	√	√	√
	Turbo Oil Temperature	√	√	√	√		√
	Fuel Temperature	√	√	√	√		√
	Intake Manifold 1 Temperature	√	√	√	√	√	√
	Air Inlet Temperature	√	√	√	√		√
	Exhaust Gas Temperature	√	√	√	√	√	√
	Auxiliary Temperature 1	√	√	√	√		√
None	Engine ECU Temperature	√					√
None	Exhaust Gas Port 1 Temperature	√					√
None	Exhaust Gas Port 2 Temperature	√					√
None	Turbo 1 Compressor Inlet Temperature	√					√
PERCENTAGE (%)							
	Fuel Level	√	√	√			√
	Acceleration Position	√	√	√	√		√
None	Throttle Position	√	√				√
	Engine Oil Level	√	√	√	√		√

8. Data Parameters Monitored - continued

Icon	Parameter	Datalinks		Screens			
		J1939	J1587	Tri	Quad	Uni	DB
PERCENTAGE (%)							
	Coolant Level	√	√	√	√		√
	Estimated Percent Fan Speed	√		√	√		√
	Drivers Demand Percent Torque	√					√
	Actual Engine Percent Torque	√		√	√		√
	Torque Use at RPM	√	√	√	√		√
SPEED (RPM, km/h, MPH or KTS)							
None	Input Shaft Speed	√	√				√
None	Output Shaft Speed	√	√				√
	Engine Speed	√	√	√	√	√	√
None	Turbo 1 Speed	√	√				√
None	Engine Desired Operating Speed	√					√
	Navigation Wheel Based Vehicle Speed	√	√	√	√		√
TIME (h)							
	Total Engine Hours	√	√	√			√
	Trip Engine Hours	√	√	√	√		√
None	Service Hours						√
MISCELLANEOUS							
None	Torque Converter Lock-Up Engaged	√					√
	Current Gear	√		√	√		√
	Selected Gear	√		√	√		√
None	CANTX Disable	√					√

Note. This list is current at the time of going to press, new parameters are continually being added - the latest list may be found in the latest datasheet (available via www.congsbergautomotive.com).

9. Active and Stored Alarm Lists

Active alarms. When an active/current alarm is received, a flashing pop-up window appears overlaid on the current screen in use, showing details of the current alarm. When an active alarm is received, the Engine Monitor activates its internal sounder, and the external alarm output on Pin 11 (if available on the CANtrak you have chosen).

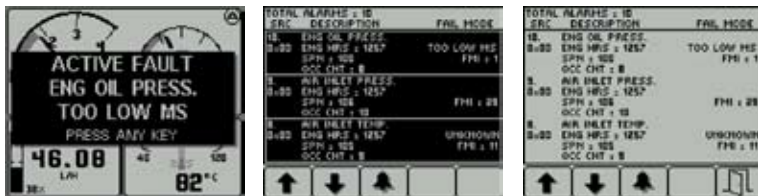

Figure 6. Example alarm message, plus alarm list screens showing unacknowledged conditions (black background) and acknowledged alarms (grey background). After acknowledgement, the exit key (open door icon) becomes active. J1939-standard abbreviations are used wherever possible. Note. “MS” = Most Severe, “MOD”= Moderately Severe and “LS” = Least Severe.

The alarm list is accessed by pressing any key while an alarm pop-up is displayed, or by pressing any of the first 4 keys to show the button bar, and then key 4. This screen displays all current active alarms; when entered, Pin 11 External Alarm Output is deactivated (if the function is available). Alarms not yet acknowledged are shown in grey on black. Alarms already acknowledged are shown in black on grey. If engine hours data is available, the list indicates when the alarm was initiated.

9. Active and Stored Alarm Lists - continued

When first entering the screen, the list automatically displays the most recent alarm. The list can be scrolled using keys 1 and 2. This screen cannot be exited until all alarms have been acknowledged by pressing key 3. Alarm messages are automatically cleared from the list when no longer received by the Engine Monitor.

Stored alarms. Alarms stored by engine/transmission ECU's (i.e. not active or current but old/historical alarms) may be viewed by pressing and holding key 4 while the active alarm list screen is visible. On entry to this page, the Engine Monitor sends a data request to the engine/transmission. The engine/transmission sends the stored alarm data to the Engine Monitor, which is decoded and displayed in a similar fashion to active alarms. The Engine Monitor displays an error message if there is no response from the engine/transmission. If the engine/transmission supports the erasure of stored alarms, they may now be erased by holding key 3.

TOTAL STORED ALARMS : 7		
SRC	DESCRIPTION	FAIL MODE
.6 0x16 Ⓟ	ENG OIL FILTER PRESS. SPN : 99 OCC CNT : 5	DISCONNECTED FMI : 5
.5 0x00 Ⓟ	ENG OIL LEVEL SPN : 98 OCC CNT : 4	VOLTAGE LOW FMI : 4
.4 0x00 Ⓟ	WATER IN FUEL SPN : 97 OCC CNT : 3	VOLTAGE HIGH FMI : 3
↑	↓	HOLD RESET
		↩

Figure 7. An example Stored Alarm List screen.

10. Configuration Menu

This mode allows users to set various Engine Monitor operating parameters such as imperial or metric units, scale limits for speedometer, engine service interval, etc. The configuration menu is entered by pressing and holding key 5 (the right hand key) for at least 3 seconds while the Engine Monitor is in normal operating mode. The top level configuration menu will be displayed as shown. Keys 1 and 2 then allow you to choose from SETTINGS, SYSTEM or Db VIEWER (The chosen item is highlighted in bold with an arrow pointing to it). Pressing key 4 enters the chosen sub-menu. SETTINGS allows the Engine Monitor to be configured according to user preferences. SYSTEM accesses maintenance and low level system configuration settings. Db VIEWER allows the user to view all data (including that that cannot be found in the graphical screens) that the Engine Monitor decodes. Each of these sub-menus is described in more detail on the pages following. Pressing key 5 exits the current menu/sub-menu. Settings are automatically stored on exit.

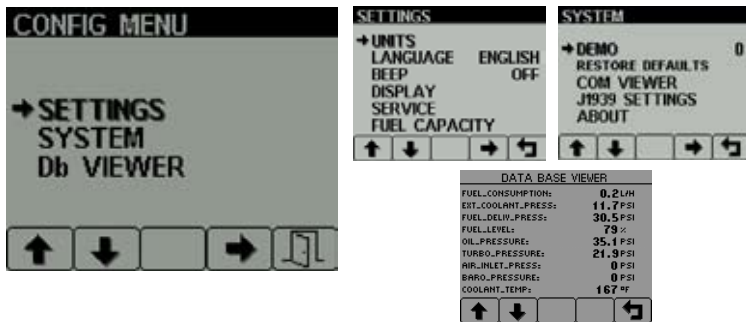
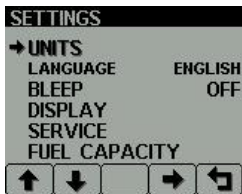

Figure 8. The top level Configuration menu and its three choices of SETTINGS, SYSTEM and Db VIEWER sub-menus. Pressing Key 4 enters the menu highlighted. Key 5 (‘exit door’ - the right hand button) returns you to the previous menu.

10. Settings Sub-Menu (2nd Level Configuration Menu)



The settings menu allows the user to enter sub-level screens to configure:

UNITS: This menu enables the user to set the units used for speed, distance, pressure, volume and temperature.

LANGUAGE: Choose from various languages.

BLEEP: When activated, the soft keys will emit an audible “bleep”. Use this menu to switch the function on/off. An audible “bleep” will still sound if an alarm occurs.

DISPLAY: The display menu allows the user to configure certain visual parameters and controls of the display.

MAX RPM: This defines and restricts the upper limit of the RPM gauges displayed throughout the Engine Monitor.

MAX SPEED: This defines and restricts the upper limit of the Speed gauges displayed throughout the Engine Monitor.

GRAPH RANGE: This changes the resolution of the historic data displayed in the Uni Display.

QUAD ADJUST: This setting allows the user to disable the ‘adjust mode’ feature in the Quad Displays. This is generally used for users who would like to fix the parameters displayed on the screens once they are happy with them. This can be re-enabled at any time.

SERVICE: Set the service interval in hours and reset the interval counter. It is important to note that setting SERVICE to 0 will disable the service interval function and the word “OFF” will be displayed.

FUEL CAPACITY: The fuel capacity screen allows the user to enter the fuel tank capacity of the vehicle. By default the fuel tank capacity will be set to 0. Only after this has been set will the parameters Fuel Remaining and Distance Remaining be calculated.

10. System Sub-Menu (2nd Level Configuration Menu)



The System menu allows the user to configure or view:

DEMO: Switches between the Engine Monitor's demonstration modes and the normal mode of displaying live engine/transmission data. Demo allows the Engine Monitor to operate without live data and provides 3 levels of simulation data: 1 = Speed On; 2 = Speed Off; 3 = Alarms On (0 = OFF). Demo is automatically set to OFF if live data is received.

RESTORE DEFAULTS: This allows you to reset all configuration information to default metric or imperial values. The default settings are:

Setting	Metric	Imperial
Language	English	
Max. RPM	4000	
Max. Speed	110 KmH	70 MPH
Graph range	2 mins	
Speed	KmH*	MPH*
Distance	Km*	Miles*
Pressure	kPa	PSI
Volume	L	Gal
Temperature	°C	°F
Demo Mode	0	

*In MEM the defaults for speed and distance is Knots and Nmiles respectively. This is the same for metric and imperial.

10. System Sub-Menu - continued

COM VIEWER: Displays last messages received on J1939 (CAN), NMEA 0183 (GPS-derived speed over ground data) and J1587 ports. System settings stored in memory can be seen in the EEPROM Viewer.

Note. This is a diagnostic feature that displays the contents of the EEPROM with the current values. This may be helpful for OEMs/users diagnosing faults.

DATALINK SETTINGS:

This sub-menu allows the user to configure the common datalink settings (Speed Source & Trip Source) as well as the individual J1939/J1587 settings (such as source addresses).

J1939 SETTINGS: This screen allows adjustments specific to the J1939 Datalink.

SOURCE ADDRESS 1 & 2: These settings allow the display to filter which sources it will listen to for data. Every device on a J1939 network will have a unique address (in the range 0-254) which the Engine Monitor can choose to listen to or not. The Engine Monitor can listen to 2 sources of data simultaneously (usually Engine 1 - address 0 and Transmission 1 - address 3). The filter can also be removed so that the Engine Monitor will decode all incoming data regardless of its source. This is accomplished by setting "Source Address 1" to 255.

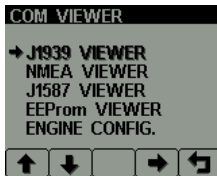

10. System Sub-Menu - continued

DISPLAY ADDRESS: As mentioned previously, every device has a unique address and the Engine Monitor is no different. In single engine setups the default display address is 40 (SAE recommendation). If the Engine Monitor does not display all necessary data (which is supported) please contact your engine manufacturer for advice on the value of this setting.

ALARM FILTER: This setting specifies whether the Engine Monitor will monitor and display alarms from all sources (GLB, global) or only the source address' specified in the settings Source Address 1 & 2 (SRC, source).

SPN VERSION: Set the Suspect Parameter Number [Version 1, 2 or 3]. Version 4 is automatically detected, but older engines will have to be set to 1, 2 or 3.

Note. Consult your engine supplier to establish which SPN version is appropriate if you have problems reading alarm data.

J1587 SETTINGS: This screen allows adjustments specific to the J1587 Datalink.

SOURCE ADDRESS 1 & 2: J1587 supports source addresses in the form of the MID (Message ID) and has values defined from 128 (Engine 1) to 250 (Steering Column Unit) with all other values reserved. 255 is a special case, it indicates all data from all sources in its raw data form. Source Address 1 defaults to 128 and Source Address 2 defaults to 130.

DISPLAY ADDRESS: The display address allows values from 128-255.

ALARM FILTER: This setting specifies whether the Engine Monitor will monitor and display alarms from all sources (GLB, global) or only the source address' specified in the settings Source Address 1 & 2 (SRC, source).



J1587 SETTINGS	
→ SOURCE ADDRESS 1	128
SOURCE ADDRESS 2	130
DISPLAY ADDRESS	171
ALARM FILTER	SRC

↑ ↓ - + ↶

10. System Sub-Menu - continued

SPEED SOURCE: There are currently 3 sources of speed data, which the Engine Monitor can decode. The settings for this parameter are AUTO, NMEA, WHEEL, NAV and OFF. AUTO prioritises the following sources (highest to lowest) NMEA, WHEEL (PGN 0xFEF1), NAV (PGN 0xFEF8). The remaining settings force the Engine Monitor to listen only for that particular source (and OFF stops the Engine Monitor listening to any source).

PIN SETTINGS: By default this security feature is disabled within the software. By enabling this feature the user will be prompted to enter a PIN every time the Configuration menu is entered.

This is to allow the unit's settings to be preserved and not be accidentally changed by an unauthorised user. To enable the PIN entry feature highlight the corresponding setting in the PIN Setting's menu and press key 4 to select it. As an added security feature (to stop the pin being enabled without knowing it) the current pin must be entered (default is "1111"). Once this has been entered the feature will be enabled. It is possible to change the pin using the Pin Change menu. This will then prompt the user for the current pin and providing this is correct the Engine Monitor will prompt the user for the new pin and finally confirmation of the new pin.

ABOUT: Displays the following product information

ID: Serial number of the display

EEPROM: Number of writes on EEPROM

PART No: Unit part number

VERS: Software version number

CHK: Flash memory checksum

SOURCE: The source of received data

LIB1: Low level system library version

LIB2: Low level Graphical Display Interface library version (if used).

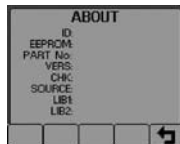
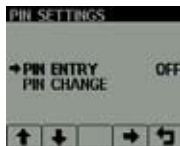

11. Pop-Up Messages and Warnings

ENGINE SERVICE WARNING. In the Configuration menu, users can set the engine service interval in hours. When the Engine Monitor determines an engine service is due, it displays SERVICE REQUIRED on the splash screen that appears at power-up.

DATA COMMUNICATIONS FAILURE. If the Engine Monitor cannot detect engine/transmission data broadcasts, a pop-up window with a data communications failure warning icon will appear and flash. Once engine/transmission data is detected the warning disappears and normal data display resumes.

CAN TX DISABLE. If CAN TX (transmission) is disabled, then the status will be displayed, with a pop-up window flashing with a period of approximately 1 second on, 10 seconds off. Note. This function is a requirement of the J1939 specification and is not normally of importance for the Engine Monitor applications.

DATA NOT SUPPORTED. If the required data parameter is not available, the gauge will display " - - - " near the units and parameter icon (see below centre for example)

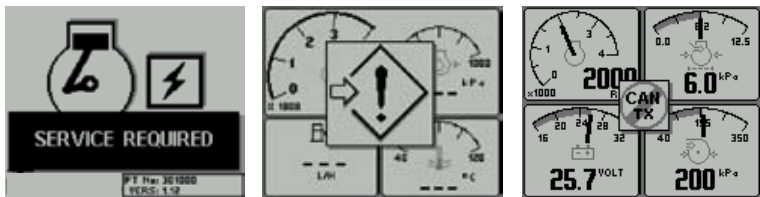

Figure 9. Left to right. Pop-up warnings of: engine service required, a data communications failure, and CAN TX is disabled.

12. Adjusting Lighting and Contrast

Pressing key 5 (the right-hand key) when the menu icons are not being displayed brings up the lighting and contrast menu. The LCD has a number of back-lighting levels that allow the display to be read in the dark. The appropriate level is selected by pressing keys 1 or 2 to decrease or increase illumination. Contrast is adjusted in the same manner, using keys 3 and 4 (Figure 10). Note. The Engine Monitor monitors the temperature of the LCD and automatically adjusts display contrast as required, therefore it is not likely that a user will need to make a manual contrast adjustment unless extreme climate changes occur. The menu is exited by pressing key 5. The lighting and contrast settings are retained after the unit is switched off.

Note. Resetting contrast. If the contrast has been adjusted poorly, you may restore the factory setting (a central value) by pressing keys 1 to 4 simultaneously. This action does not change other user-configured settings.

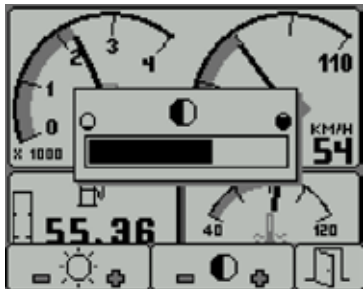

Figure 10. The lighting and contrast adjust screen, showing a contrast level adjustment in progress.

13. Preferred Screen Store

The Engine Monitor automatically stores the current screen as a user's preferred page, after a delay of approximately 15 seconds (if no buttons are pushed). On next power-up the display will start with the splash screen, and then go to the last stored screen. Note. Selecting Restore Defaults on the Systems sub-menu of Configuration will set the main engine screen as the default display.

14. Keypad Lock

The Engine Monitor's five keys can be locked, such that an operator cannot change any settings or access any other display mode. (in a similar manner to the key lock functions on a mobile phone). This is achieved by pressing and holding keys 1 and 5 simultaneously for one second. Repeating this operation resets the Engine Monitor/CANtrak back to normal operation.

15. Connector Pin-Out

The Engine Monitor interfaces to data via the Deutsch DT0412PA connector on the rear of the display - wired as shown. Kongsberg Automotive can supply 2 harnesses for this purpose:

A Power/CAN/Output* harness - Part No. 510623

A Power/CAN/GPS** harness - Part No. 510626

Alternatively, Kongsberg Automotive can supply the mating connector parts in kit form (Part No. 531006). Similarly you can source them from Deutsch (www.deutschecd.com):

DT0612SA, mating connector

W12S, wedgelock (one per connector)

0462-201-1631, pin sockets (note that different finishes and termination methods may be selected)

114017, sealing plug (one per unused pin location)

(*If supported by the hardware platform)

(**If supported by the software platform)

Note. A ferrite clamp must be placed over the harness to meet EMC radiated emission requirements of BSEN60945 (Maritime navigation & radio communication equipment & systems). We recommend that the clamp should be a TDK ZCAT2032-0930, a Multicomp 33RH17 5X28 5X10 7: core, 10.7MM ID or equivalent.

15. Connector Pin-Out - continued

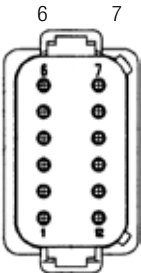
Connector pin-out	Signal	Notes	
	1	Power -	Ground & power (10-30V DC). Supply should be protected by 500mA-rated circuit breaker/fuse
	2	Power +	
	3	TX (+)	RS-232 serial port
	4	TX (-)	
	5	RX (-)	
	6	RX (+)	
	7	CAN LO (J1939 LO)	CAN2.0B port
	8	CAN HI (J1939 HI)	
	9	RS485A (J1587+)	Serial port
	10	RS485B (J1587-)	
	11	Output	Programmable digital output for activating alarm*
	12	Not used	

* Not available on all Engine Monitor models - refer to the datasheet for your display.

16. Typical J1939 Wiring Topology

Most Modern engine installations include a harness with built in J1939 backbone (Check engine manufacturer's documentation). If not, it is critical to use twisted shielded pair with a drain wire (max length 40m) terminated with 120Ω resistors at each end. In addition, all stubs should not exceed 1m in length.

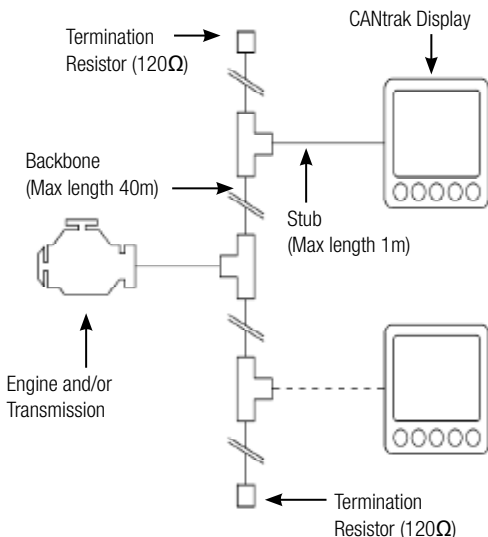

17. Installation

Front mounting instructions. Most units will be mounted onto a bulkhead, dashboard or panel - a method described below; the components required (4 x M4 studs and thumbnuts) are supplied with every Engine Monitor.

Instructions:

- Decide on a location.
- Allow adequate clearance behind the display for cable connections, to ensure that the cables are not unduly stressed, and for ventilation. Leave sufficient cable so that the unit may be removed for servicing.
- Using the template supplied with the display as a guide, cut out the mounting hole, and drill four $\varnothing 4.3\text{mm}$ (0.170inch) holes for the M4 studs.
- Screw the studs into the rear case; longer studs can be used (not supplied).
- Connect the cable (not supplied).
- Place the Engine Monitor in position, secure by screwing thumbnuts onto the studs.

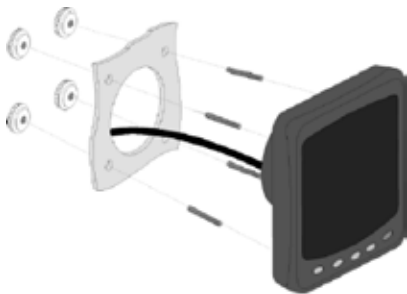

The front mounting kit (M4 studs and thumbnuts) supplied with the Engine Monitor, which allows the display to be mounted onto a panel or dashboard.

Warning. Take care not to over tighten the studs/thumbnuts as this may damage the unit.

17. Installation - continued

Front mounting template. A paper mounting template for marking drill holes etc, is supplied loose with the Engine Monitor. After marking out, Kongsberg Automotive advises that dimensions are verified by measurement, due to the limitations of the printing process. This is especially important if the template has been photocopied.

Other mounting options

Rear mounting CANtrak 2600 and 2610 displays. Users can also mount most Engine Monitor's displays from the rear of a panel. Users can either fabricate their own mounting arrangements or use Kongsberg Automotive's Rear Mounting Bracket: Part Number 900061 (see datasheet at www.kongsbergautomotive.com for details). Take the same precautions as when front mounting. Contact Kongsberg Automotive if you require a mounting template.



Trunnion mounting

All Engine Monitor displays may, optionally, be attached to a surface using a Trunnion Mounting Bracket (see left).

A datasheet on this Kongsberg Automotive Part (No. 930293) is available via www.kongsbergautomotive.com

18. Maintenance and Troubleshooting

No regular maintenance is required, except for cleaning the Engine Monitor lens as required using a soft, damp cloth. Do not use abrasive materials or solvents, specifically white spirit, petrol and acetone. Should any further attention be necessary, please contact your supplier. If you are experiencing operating problems with the Engine Monitor, check these diagnostics:

Problem	Possible solution
Unit does not power up	Ensure connections to unit are correct. Ensure power source is present.
Display is blank or black	Adjust/reset lighting and contrast settings. Ensure temperature is within operating range of the unit.
Unit beeps at start-up and does not store settings	Unit has failed self-test. Contact your Engine Monitor supplier
Unit fails to display any data	Ensure connections to unit are correct. Ensure data source supports J1939 or J1587 message protocol.
Unit fails to display certain parameter(s)/unable to select certain parameter(s)	Ensure the Engine Monitor supports required parameter(s) Ensure data source provides required parameter(s).
Active alarm messages are not displayed	Ensure data source provides alarm message data in the following format: J1939 Active Diagnostic Trouble Codes- Diagnostic Message 1 (DM1).
Stored alarm messages are not displayed	Ensure data source provides alarm message data in the following format: J1939 Active Diagnostic Trouble Codes- Diagnostic Message 2 (DM2).

19. The CANtrak Platform

The Engine Monitor software runs on Kongsberg Automotive' CANtrak LCD displays. These are rugged 110x110mm DIN-format modules with 5 soft keys, and offer a 160 x 128 pixel display area. This is large enough to provide great flexibility for managing the rich data available from modern electronically controlled systems. CANtrak is now in its fourth generation: the latest CANtrak 2600 family employs design-for-manufacture techniques including chip-on-tab to minimise component count and assembly operations. The CANtrak 2600 series of displays employ film supertwist nematic LCDs for visibility in direct sunlight - with backlighting.

They offer a Deutsch connector interface to the network, and protection to IP67 which covers immersion in water up to 1 meter. Units come with 3 serial interfaces: RS-232, RS-485, and a CAN 2.0B port compatible with the J1939 protocol used by many manufacturers. There are 2 variants: CANtrak 2600 operates over a range of -25 to +75°C; 2610 incorporates a heating element, supporting automotive industry requirements of -40°C. The CANtrak 2610 also includes a programmable 500mA digital Output Driver. Datasheets via: www.kongsbergautomotive.com

20. Software Development Options for the CANtrak

Customers have a range of options for creating user interfaces on CANtrak:

Like a PC, a CANtrak needs application software to provide a useful function. The Engine Monitor application software, written by Kongsberg Automotive, is just one example. CANtraks may be programmed to perform an infinite number of display, control and data logging tasks. To help modify existing software or write new application software Kongsberg Automotive has developed a software development kit (SDK). This is available for programming the microcontroller used in CANtrak - allowing complete control of the display hardware. Purchasers of a SDK and suitable compiler are given a number of hours of free technical support from Kongsberg Automotive's application engineering team - which may be used to write some or all of the customer-specified application software; alternatively the time may be used for training, trouble-shooting and advice.

As well as supplying and supporting the SDK, Kongsberg Automotive offers a fast-turnaround and cost effective software development service for CANtraks using the same SDK. These projects can range from something as simple as placing a customer's logo on the splash screen, through additional pages of data on a branded version of the Engine Monitor, to a full application with custom user interfaces, control programs, communication protocols, etc.

If you would like to discuss the purchase of an SDK, or obtain a quote for custom application software, please contact us. More information is available via www.kongsbergautomotive.com

21. Glossary

CAN	Controller Area Network (also referred to as CANbus); serial communications protocol for automotive use
CANtrak	Intelligent CAN-compatible LCD display module
FMI	Failure Mode Identifier
GPS	Global Positioning System
HMI	Human-Machine Interface
ISO	International Standard Organisation
J1939	SAE engine data protocol using CAN 2.0B
J1587	Electronic Data Interchange between Microcomputer Systems in Heavy-Duty Vehicle Applications
LCD	Liquid Crystal Display
NMEA	National Marine Electronics Association; serial communications protocol for marine use
PID	Parameter Identifier
RS-232	Standard electrical interface for serial communications
RS-485	Standard differential electrical interface for serial communications
SAE	Society of Automotive Engineers Inc.
SID	Subsystem Identifier
Soft keys	Push-button keys whose function changes according to use
SPN	Suspect Parameter Number: J1939-specific fault code ID number

Note. The messages, icons, error codes etc displayed by the Engine Monitor conform to J1939 standards wherever possible. A copy of the relevant standards documents will be important for developers - they may be accessed and purchased via: www.sae.org/standardsdev/groundvehicle/j1939a.htm

22. Important Safety and Legal Information

Under no circumstances shall Kongsberg Automotive or any of its subsidiary companies accept liability for any loss of data, income, incidental damage or consequential losses incurred as a result of the use of the product howsoever caused when used as a monitor for electronically-controlled engines/transmissions or other systems.

- Reproduction, transfer, distribution or storage of part or all of the contents in this document in any form without written permission of Kongsberg Automotive is prohibited.
- Kongsberg Automotive operates a policy of continuous improvement. Kongsberg Automotive reserves the right to alter and improve the CANtrak displays and the Engine Monitor software without prior notice.

Liquid crystal safety. If the liquid crystal display (LCD) is broken, particular care must be taken with any leaking fluid. Urgent action must be taken:

- If the LCD fluid gets onto your skin wipe immediately with a suitable cloth and wash the area well with mild soap and water.
- If the LCD fluid gets into your eye thoroughly rinse your eye with clean water for several minutes and then gain immediate medical assistance.
- If the LCD fluid is swallowed rinse your mouth thoroughly with clean water then drink a substantial volume of water and make yourself vomit. Then gain immediate medical assistance.

CE EMC Directive 89/336/EE. This product has been designed to be compliant with this directive. Compliance can only be ensured by correct installation.

Manufacturing and European Sales

Christopher Martin Road,
Basildon,
Essex,
SS14 3ES
England

Tel: +44 (0)1268 522861
Fax: +44 (0)1268 282994

Email: cantrak.info@ka-group.com
www.kongsbergautomotive.com

Manufacturing & North American Sales

Kongsberg Automotive
90, 28e Rue
Grand-Mère (Qc)
G9T 7E9
Canada

Tel: 819-533-3201
Fax: 819-533-5317

©Kongsberg Automotive 2008. Specifications subject to change without notice.
Any trademarks used are recognised and are the property of their respective owners.

Part Number 806620 - V3
Feb 2008

